

Montageanleitung

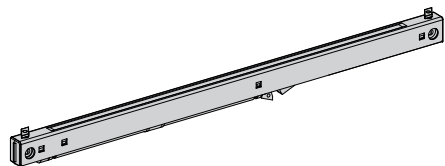

Schiebetürbeschlag 50/80kg Holz



i Dämpfung 1-seitig

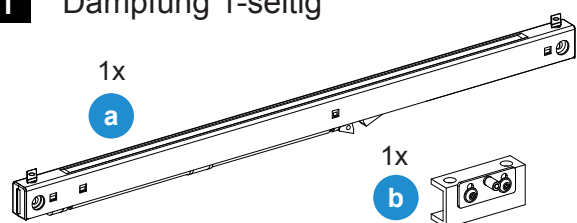

i Dämpfung 2-seitig

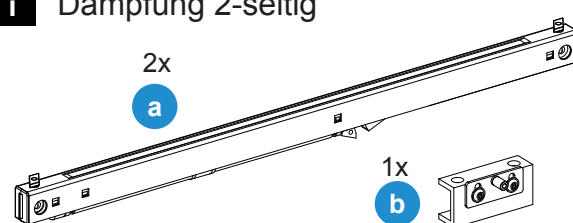

i Dämpfung 80

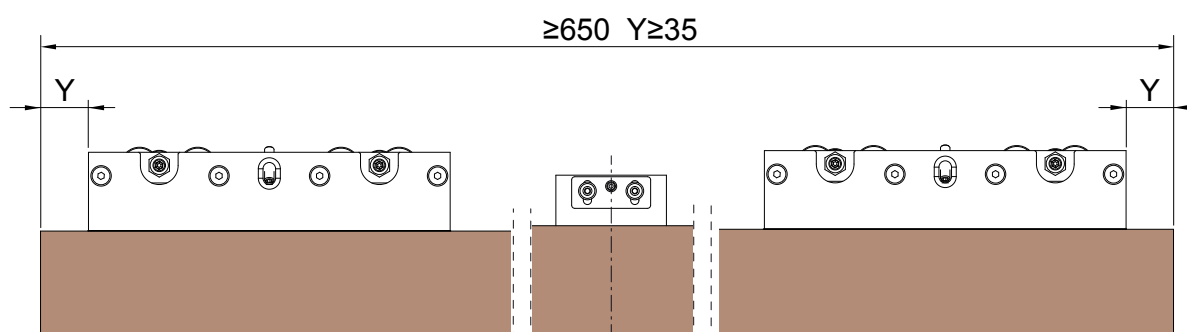

i Dämpfung 50

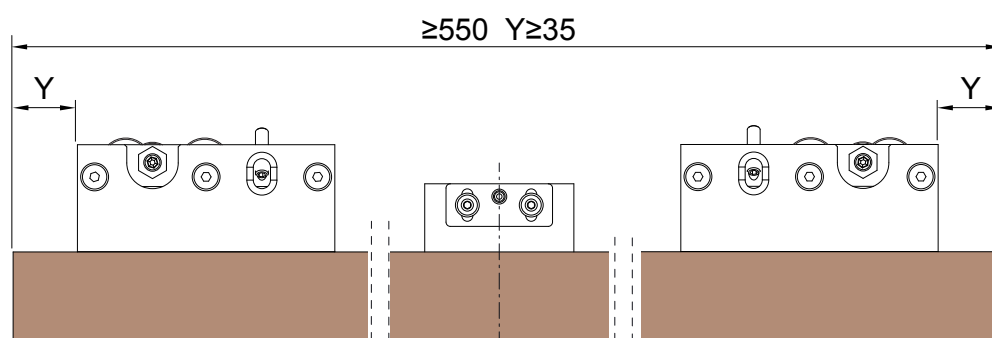

1

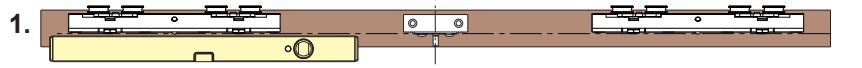
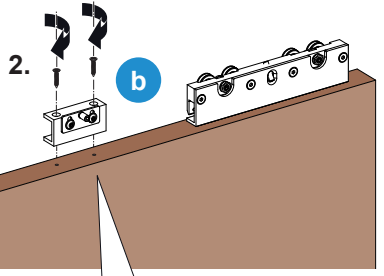
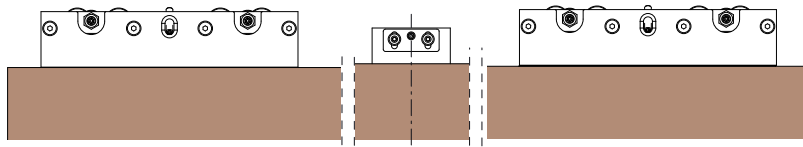

2

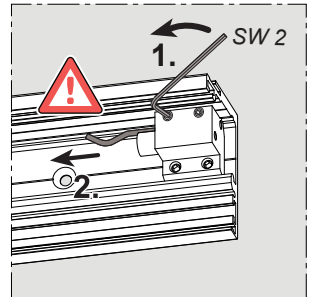
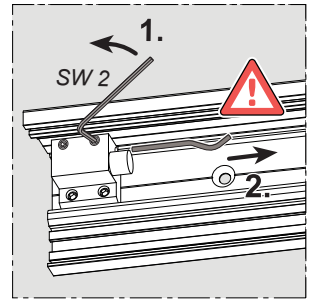

3

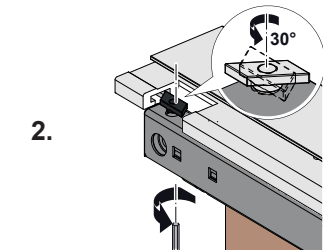
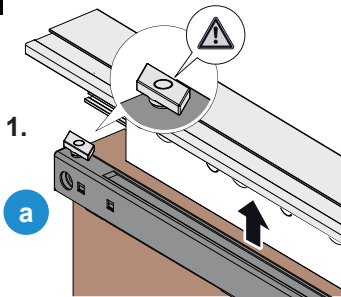

4

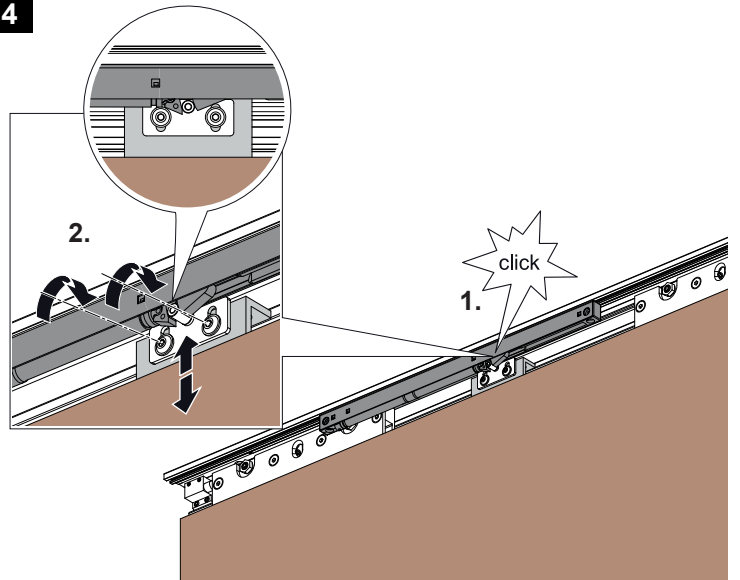

5

